



SPC-8000 8-port DMX512 controller

User Manual



Chapter 1 brief introduction of SPC-8000

1.1 Summary

SPC-8000 is a Controller of our company specially designs for the large-scale LED control system. Adopts 32bits high speed ARM+DSP processor, SPC-8000 makes the excess of light scene more smooth and soft ,and fully guarantees the reliability of system stability. With the powerful editor and player software DMX-NET, it can control the regular and other special-shaped various point, line, surface Light Source. Besides, it can support both on-line and off-line operation mode. Through Ethernet, it is able to implement remote control.

1.2 Features:

1. Eight groups of international standards DMX512/1990 signal outputs with photoelectric isolation



Shanghai Semping Electronics CO., Ltd.

(2500V isolation voltage), 4096 DMX channels, 1360 full-color RGB lamps with 256 gray scale levels for each of R/G/B can be controlled, and up to 16,770,000 colors, really achieve true color.

2. 16 * 2 LCD blue screen display, user-friendly operation interfaces.
3. Support online and offline modes, 2G SD card or MMC card to access the scene files.
4. With 4 RJ45 interfaces, support cascade and star connection networking modes.
5. Support 254 controllers' network through the LAN, composing a super-large-scale LED lighting control system, a maximum of 300,000 full-color pixels can be controlled.

1.3 Technical Specifications:

Model: SPC-8000

Input Voltage: AC 176~264V, 50Hz

Rated Power: 15W

Operating temperature: -20 °C - 60 °C

Digital signal output: DMX512/1990

Digital Signal connector: 4PIN CONNECTOR*8

Network interfaces: RJ45*4, 10/100M self-adaptive

Size: 483 (W) * 160 (H) * 43 (L) mm

Installation dimensions: standard 1U, 19" standard chassis

Weight: 1.5 kg



1.4 Schematic diagram

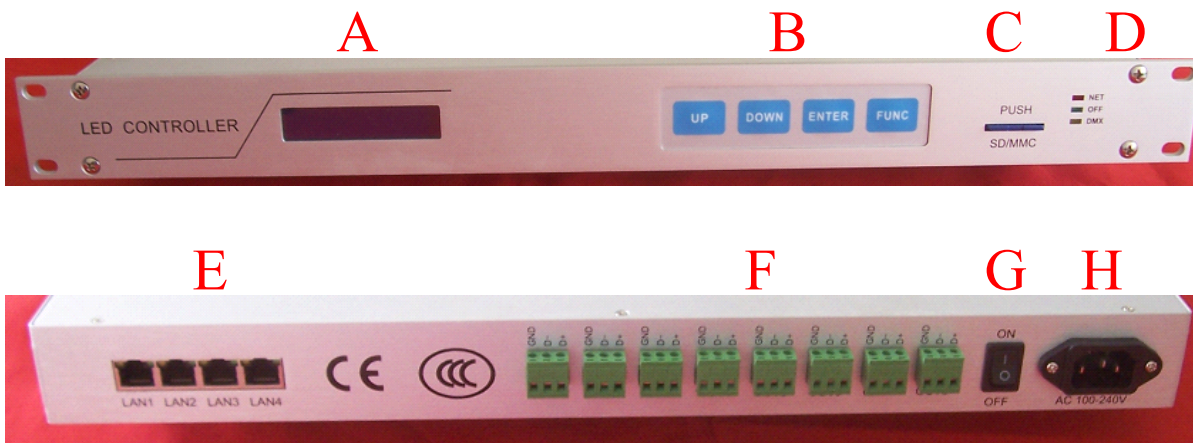

A	16*2 LCD screen
B	Function key
C	SD/MMC Card port (Notes: when insert MMC/SD card, a clicking sound indicates it has been plugged. While draw it out, ensure that it is pressed to the bottom, then loosen it, in the end it will pop automatically.))
D	System status indicator NET: Online indicator OFF: Offline indicator DMX: DMX signal transmission indicator
E	RJ45 Crystal-pin plughole
F	Eight groups of DMX512 signal output
G	ON OFF: Power switch
H	AC power supply socket



1.5 Hardware connection

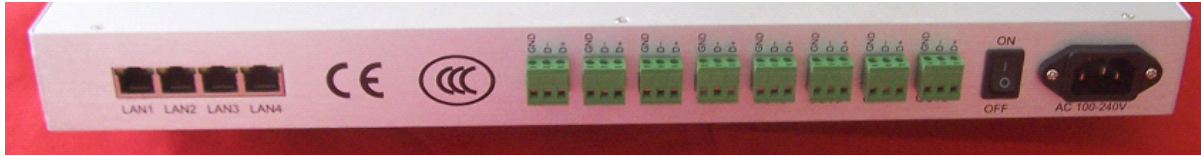

Standard **RJ45** network interface, it connects to standard direct network cable, its connection pattern is according to standard **EIA/TIA568B**:

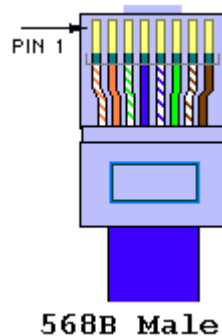

- | | |
|-------------------------------------|------------------------------------|
| Pin1: connects to orange/white wire | Pin5: connects to blue/white wire |
| Pin2: connects to orange wire | Pin6: connects to green wire |
| Pin3: connects to green/white wire | Pin7: connects to brown/white wire |
| Pin4: connects to blue wire | Pin8: connects to brown wire |

(Notes: Please be sure wiring is in accordance with the rules above, otherwise the signal attenuation will be very severe.)

Form what has mentioned above, manufacture of network cable, DMX512 signal line is required to be corresponding respectively, or unexpected trouble will occur to the system. To guarantee stability and reliability, the following requests should be paid more attention:

- 1: Ensure GND is well connected.**
- 2: It is better to adopt a shielded twisted pair, so that the external Interference to system will be minimized.**
- 3. Transmission distance of DMX512 signal line: The length of synchronous signal line between the output port and end must be within 300 meters, (this datum is based on the DMX fixtures. Different fixtures have different transmission distance) otherwise a repeater is**



required to guarantee that there is no attenuation or distortion in signal transmission.

Chapter2 Application Method

Turn on the power switch. LCD displays as follows:

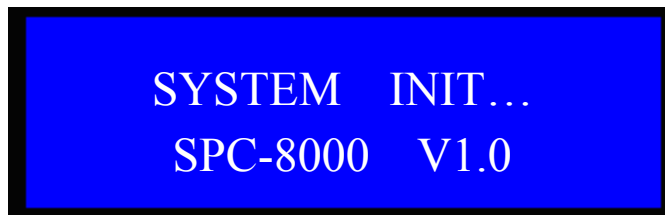

Then, SPC-8000 enters into Power-on Self-Test.

If correct files are in SD/MMC, check file 8S01C001,8S02C001,...,8S20C001 in turn, then LCD displays:



Otherwise, LCD indicates:



Then it returns to main interface, if no correct files, LCD displays:

A rectangular LCD display with a blue background and a black border. The text is white and centered, reading "SD ERROR..." on the first line and "CHECK SD PLEASE!" on the second line.

SD ERROR...
CHECK SD PLEASE!

While there are correct files in it, LCD indicates:

A rectangular LCD display with a blue background and a black border. The text is white and centered, reading "SPEED : 16" on the first line and "CYCLE SCECE : 01" on the second line.

SPEED : 16
CYCLE SCECE : 01

Speed: figure 16 indicates the current speed of this controller. Figure 1 represents the fastest, while figure 16 represents the lowest.

It can be adjusted through Enter key in main interface.

Online: Indicates the controller is in the online mode, it receives scene signal transmitted by PC software from network.

Single: Indicates the controller is in the offline single mode, it reads and runs the corresponding scene files from SD/MMC card.

Cycle: Indicates the controller is in the offline cycling mode, it reads the corresponding scene files from SD/MMC card, then run in a circular manner.

Scene: figure 01 indicates the current scene number. It can support 20 scenes under the offline mode.

In main interface, press the key UP or DOWN to change the current scene.

Press the key FUNC to enter into each menu:

A rectangular LCD display with a blue background and a black border. The text is white and centered, reading "-> A:Set IP Addr" on the first line and "B:Set Net Mask" on the second line.

-> A:Set IP Addr
B:Set Net Mask



Press UP/DOWN to set different parameters for A/B/C/D/E, press key ENTER to return to previous menu, and key FUNC to enter the mode of setting different parameters.

- A: Set IP Addr Set IP address
- B: Set Net Mask Set subnet mask for IP address.
- C: set Gateway
- D: On/Off line Choose online or offline mode

2.1 Setting IP Address

Press key FUNC to enter into IP address setting mode

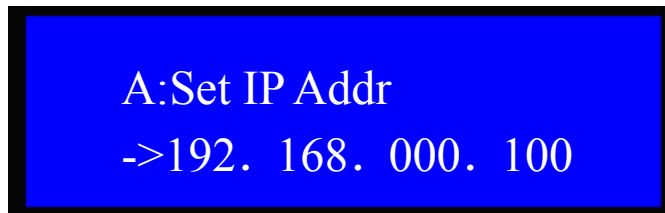

Press key UP/down to conduct +/- setting for the parameter to which arrow points.

Press the key ENTER to save IP address, and return to previous menu.

Press the key FUNC to move arrow so as to conduct setup for different parameters.

2.2 Net Mask setting

Enter Net Mask setting mode



Press key UP/down to conduct +/- setting for the parameter to which arrow points.

Press the key ENTER to save Net Mask, and return to previous menu.

Press the key FUNC to move arrow so as to conduct setup for different parameters.



2.3 Gateway setting

Enter into Gateway setting mode:

A screenshot of a blue menu box with a black border. The text inside is white and reads "C:Set Gateway" followed by "->192. 168. 000. 001" on the next line.

C:Set Gateway
->192. 168. 000. 001

Press key UP/down to conduct +/- setting for the parameter to which arrow points.

Press the key ENTER to save Gateway, and return to previous menu.

Press the key FUNC to move arrow so as to conduct setup for different parameters.

2.4 Online/Offline setting

Enter into Online/offline mode

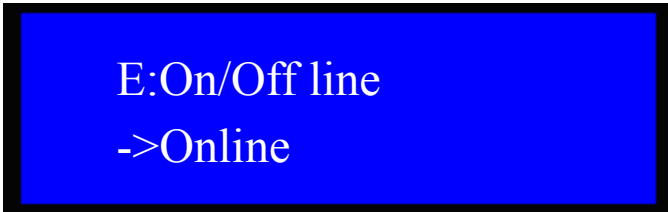
A screenshot of a blue menu box with a black border. The text inside is white and reads "E:On/Off line" followed by "->Online" on the next line.

E:On/Off line
->Online

Press key UP/down to choose Online or Offline Single/Cycle mode.

Press the key ENTER to save On/offline, and return to previous menu.



Chapter 3 online system operation

3.1 System diagram

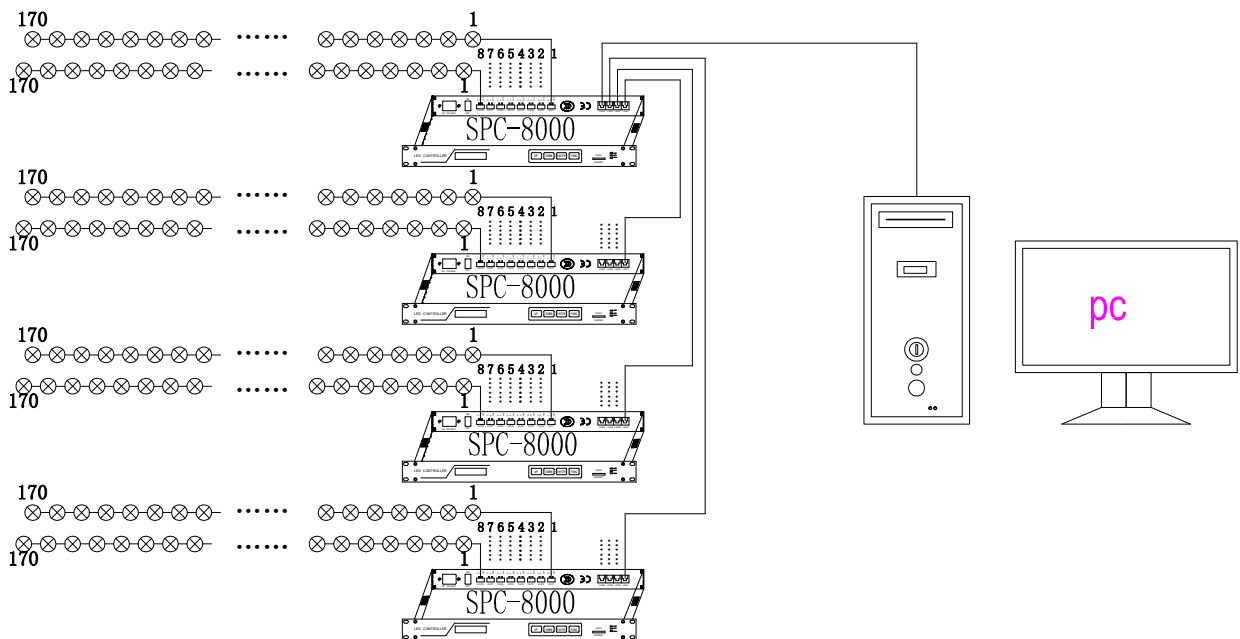

3.2 networking mode

SPC-8000 supports online control. By DMX-NET software of our company, real-time control can be conducted to each SPC-8000 which has been linked to Ethernet.(As for how to use DMX-NET software, Please refer to DMX-NET Manual)

In the online mode, the Max. refresh frequency of data transmission is 30Hz. Networking is in terms of the related regulations of standard Ethernet. Network data line is required to be Cat. 5 twisted pair. The distance between controller and Network Switch should be within 100 meters, if exceeded, it needs inserting a repeater.



3.3 Network judgement

Firstly, set parameters for SPC-8000 in accordance with the setting method above, and ensure that it is in the online mode. Secondly, run ping 192.168.0.100 -t in PC with the same Ethernet SPC-8000 connects to. LCD will display:

Pinging 192.168.0.100 with 32 bytes of data:

Reply from 192.168.0.100: bytes=32 time=2ms TTL=100

Reply from 192.168.0.100: bytes=32 time=2ms TTL=100

Reply from 192.168.0.100: bytes=32 time=2ms TTL=100

It indicates online mode works normally, otherwise please check lines and PC to confirm whether they are normal.



Chapter 4 Operation on card MMC/SD

4.1 Card MMC/SD format

In Windows environment:

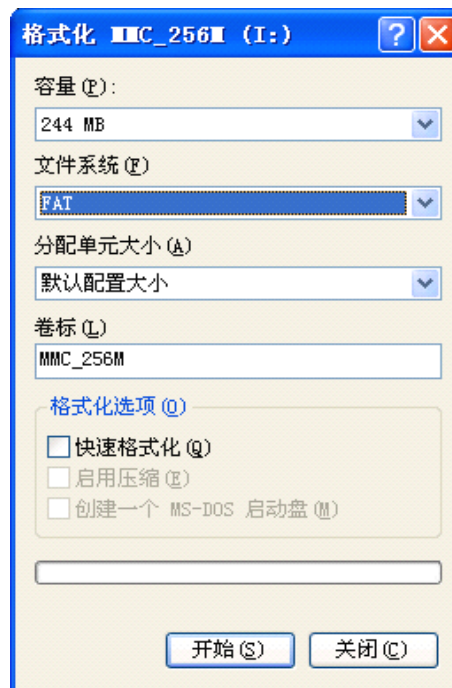

It is necessary to choose FAT file system, for at present SPC-8000 doesn't support FAT32 file system.

Need to set volume label, such as: MMC-256M

Do not pitch on the Quick Format option.

Set as on the chart above, then click the key Start , card MMC/SD formatting will be completed.

4.2 Copy and modification of scene file

After formatting, copy the files (8SxxC001.sc) generated by DMX-NET Editor to card MMC/SD. (Please refer to DMX-NET Manual of our company to look into how to use DMX-NET software).

Modification: in order to ensure the integrity and accuracy of data, please copy the original files from card MMC/SD to PC hard disk before modifying the content on the card. Then format the card and copy files into it.



Chapter 5 Mechanical size and Installment

Unit of length: mm

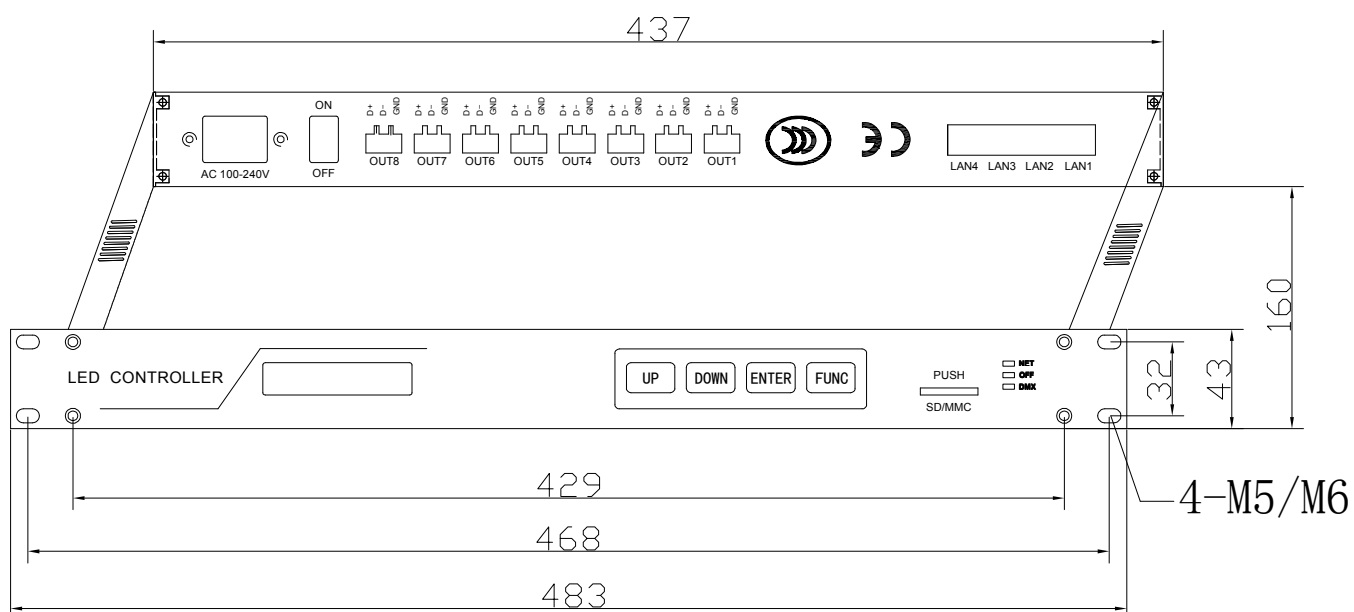

SHANGHAI SEMPING ELECTRONICS CO.,LTD.

Add: No.12, Lane 2501, Dushi Road, Minhang District, Shanghai

Tel: (86)21-5228 8520

Fax: (86)21-5228 8521

Web: www.dmx512net.com

Technical support : support@dmx512net.com